

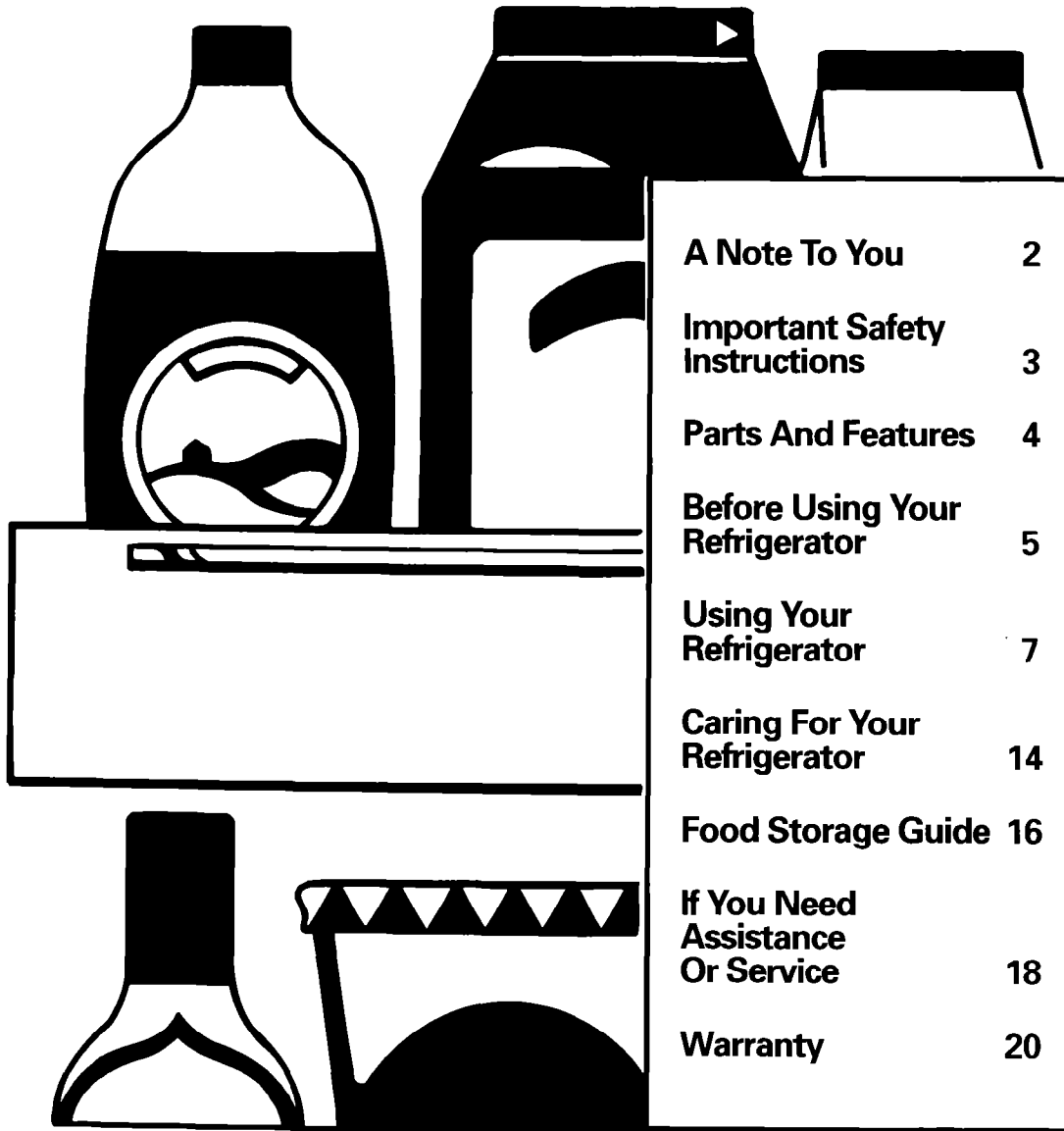

# Use And Care

## G U I D E



NO-FROST REFRIGERATOR-FREEZER

MODELS 3VET23DK 3VET21DK 3VET19DK

A

6/93

# A Note To You

## **Thank you for buying a Whirlpool appliance.**

You have purchased a quality, *world-class* home appliance. Years of engineering experience have gone into its manufacturing. To ensure that you will enjoy many years of trouble-free operation, we have developed this Use and Care Guide. It is full of valuable information on how to operate and maintain your appliance properly and safely. Please read it carefully. Also, please complete and mail the Ownership Registration Card provided with your appliance. This will help us notify you about any new information on your appliance.

## **Your safety is important to us.**

This guide contains safety symbols and statements. Please pay special attention to these symbols and follow any instructions given. Here is a brief explanation of the use of each symbol.

### **⚠ WARNING**

This symbol will help alert you to such dangers as personal injury, burns, fire and electrical shock.

### **⚠ CAUTION**

This symbol will help you avoid actions which could cause product damage (scratches, dents, etc.) and damage to your personal property.

## **Help when you need it.**

If you ever have a question concerning your appliance's operation, or if you need service, first see "If You Need Assistance Or Service" on page 18. If you need further help, feel free to call an authorized Whirlpool service company. When calling, you will need to know your appliance's complete model number and serial number. You can find this information on the model and serial number label (see diagram on page 4). For your convenience, we have included a handy place below for you to record these numbers, the purchase date from the sales slip and your dealer's name and telephone number. Keep this book and the sales slip together in a safe place for future reference.

**Model Number** \_\_\_\_\_

**Dealer Name** \_\_\_\_\_

**Serial Number** \_\_\_\_\_

**Dealer Phone** \_\_\_\_\_

**Purchase Date** \_\_\_\_\_

# Important Safety Instructions

**⚠ WARNING**

To reduce the risk of fire, electrical shock, or injury when using your refrigerator, follow these basic precautions:

- Read all instructions before using the refrigerator.
- Child entrapment and suffocation are not problems of the past. Junked or abandoned refrigerators are still dangerous ... even if they will "just sit in the garage a few days."  
If you are getting rid of your old refrigerator, do it safely.
- Never allow children to operate, play with, or crawl inside the refrigerator.
- Never clean refrigerator parts with flammable fluids. The fumes can create a fire hazard or explosion.

• FOR YOUR SAFETY •

DO NOT STORE OR USE GASOLINE OR OTHER FLAMMABLE VAPORS AND LIQUIDS IN THE VICINITY OF THIS OR ANY OTHER APPLIANCE. THE FUMES CAN CREATE A FIRE HAZARD OR EXPLOSION.

– SAVE THESE INSTRUCTIONS –

## Help us help you

Please:

- Install and level the refrigerator on a floor that will hold the weight and in an area suitable for its size and use.
- Do not install the refrigerator near an oven, radiator or other heat source.
- Do not use the refrigerator in an area where the room temperature will fall below 13°C (55°F).
- Keep the refrigerator out of the weather.
- Connect the refrigerator only to the proper kind of outlet, with the correct electrical supply and grounding.
- Do not load the refrigerator with food before it has time to get properly cold.
- Use the refrigerator only for the uses described in this manual.
- Properly maintain the refrigerator.
- Be sure the refrigerator is not used by anyone unable to operate it properly.

# Parts And Features

This section contains captioned illustrations of your appliance. Use them to become familiar with where all parts and features are located and what they look like. The model you have purchased may have all or some of the parts and features shown and they may not match the illustration exactly. This manual is designed to cover several models.

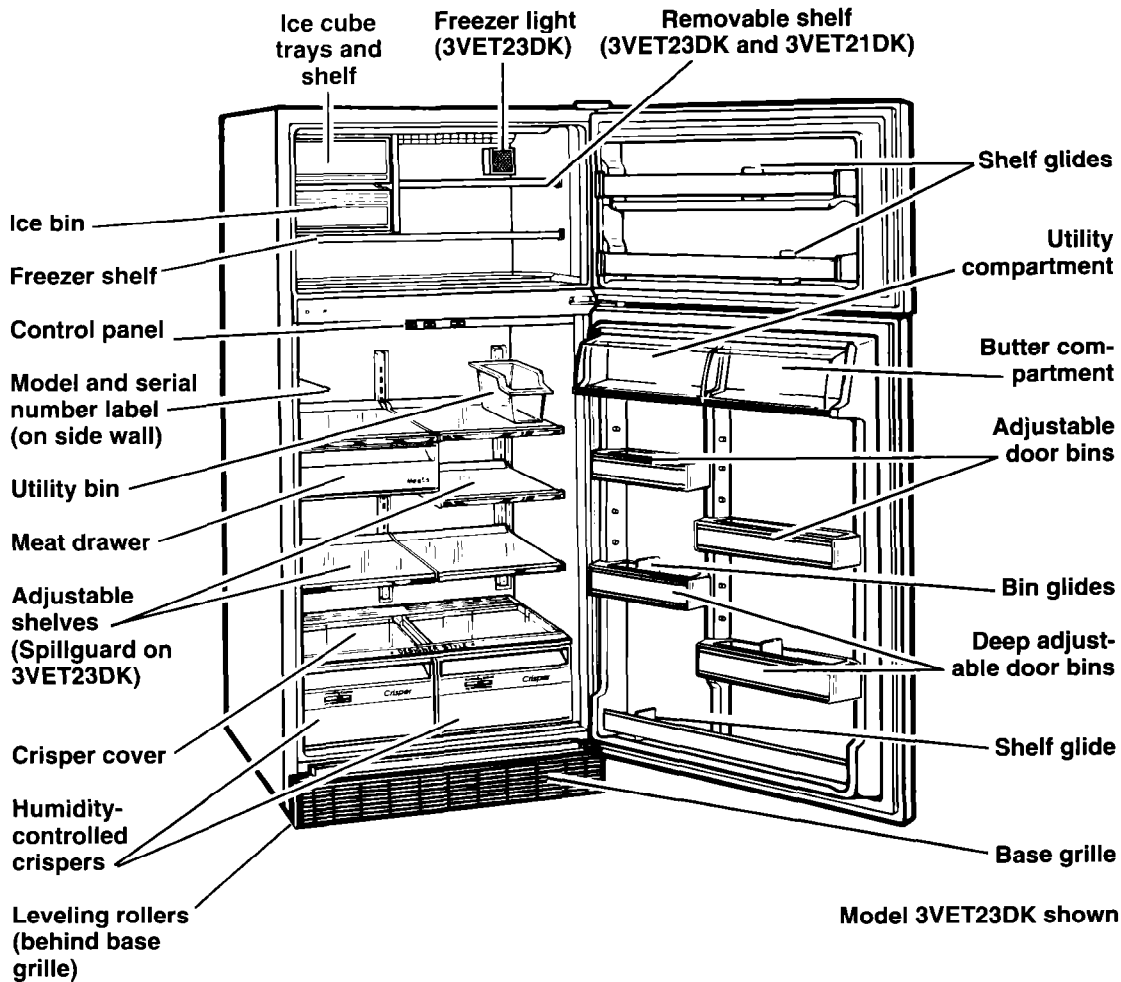

## Control panel

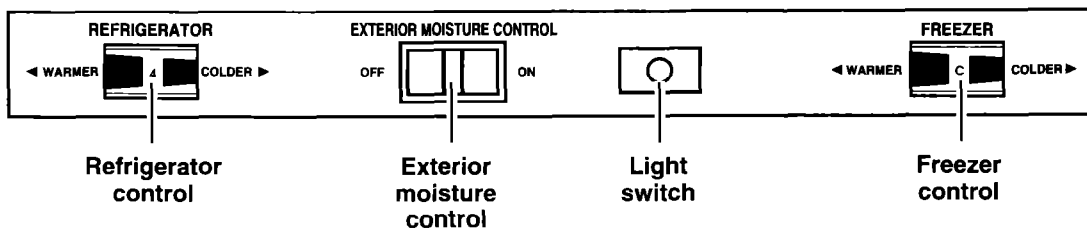

# Before Using Your Refrigerator

In This Section		Page	Page	
Cleaning it .....		5	Installing it properly .....	6
Plugging it in .....		5	Leveling it .....	6

It is important to prepare your refrigerator for use. This section will tell you how to clean it, connect it to a power source, install it and level it.

## Cleaning it

### Removing packaging materials

Remove tape and any inside labels (except the model and serial number label) before using the refrigerator.

#### To remove any remaining glue:

- Rub briskly with thumb to make a ball, then remove.

#### OR

- Soak area with liquid hand-dishwashing detergent before removing glue as described above. Do not use chart instruments, rubbing alcohol, flammable fluids or abrasive cleaners. These can damage the material. See "Important Safety Instructions" on page 3.

**NOTE:** Do not remove any permanent instruction labels inside your refrigerator. Do not remove the Tech Sheet fastened under the refrigerator at the front.

### Cleaning it before use

After removing all packaging materials, clean your refrigerator before using it, if necessary. See cleaning instructions on pages 14 and 15.

## Plugging it in

### Recommended Grounding Method

A 220 or 240 Volt, 50 Hz., AC only 15 or 20 ampere fused and properly grounded electrical supply is required. It is recommended that a separate circuit serving only this appliance be provided. Use a receptacle which cannot be turned off with a switch or pull chain. Do not use an extension cord.

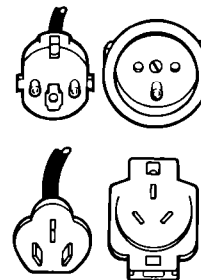

# BEFORE USING YOUR REFRIGERATOR

## Installing it properly

1. Allow 1.25 cm ( $\frac{1}{2}$  inch) space on each side and at the top of the refrigerator for ease of installation.
2. If the hinge side of the refrigerator is to be against a wall, you might want to leave extra space so the door can be opened wider.
3. The refrigerator can be flush against the back wall.

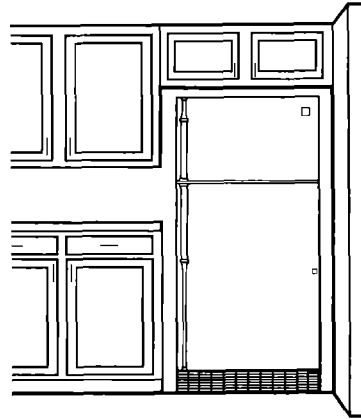

## Leveling it

Your refrigerator has 2 front leveling screws—one on the right and one on the left. To adjust one or both of these, follow the directions below.

1. Remove base grille. (See page 12.)
2. To raise front, turn screw clockwise.
3. To lower front, turn screw counterclockwise.
4. Check with level.
5. Replace base grille. (See page 12.)

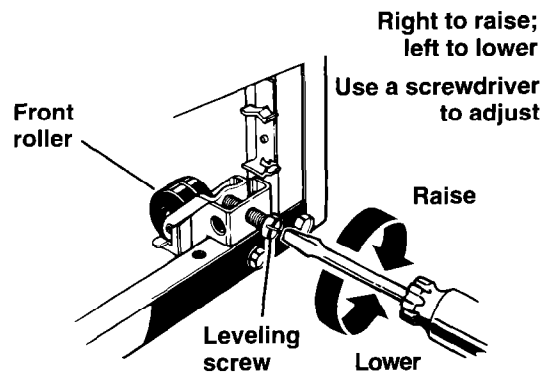

# Using Your Refrigerator

In This Section		Page	Page
Setting the controls .....	7	Removing the freezer shelf .....	11
Changing the control settings .....	8	Raising the ice compartment door .	11
Adjusting the door bins .....	9	Using the ice cube trays .....	11
Adjusting the bin/shelf glides .....	9	Changing the light bulbs .....	12
Adjusting the refrigerator shelves ....	9	Removing the base grille .....	12
Removing the meat drawer and cover .....	10	Reversing the door swing .....	13
Removing the crispers and crisper cover .....	10	Understanding the sounds you may hear .....	13
Adjusting the crisper humidity control .....	11	Saving energy .....	13

In order to obtain the best possible results from your refrigerator, it is important that you operate it properly. This section will tell you how to do just that.

## Setting the controls

### Temperature controls

Controls for the refrigerator and freezer are in the refrigerator. When the refrigerator is plugged in for the first time:

**1. Set the Refrigerator Control to 4.**

Refrigerator Control adjustments range from 1 (warmest) to 8 (coldest).

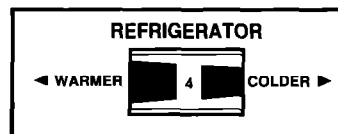

**2. Set the Freezer Control to C.**

Freezer Control adjustments range from A (coldest) to D (warmest).

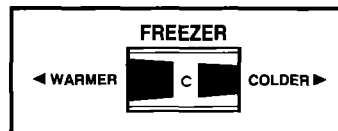

**3. Give the refrigerator time to cool down completely before adding food. This may take several hours.**

The settings indicated above should be correct for normal, household refrigerator usage. The controls will be set correctly when milk or juice is as cold as you like and when ice cream is firm. If you need to adjust these settings, see "Changing the control settings" on page 8.

# USING YOUR REFRIGERATOR

## Exterior moisture control

The Exterior Moisture Control operates electric heaters around the door openings. These heaters help keep moisture from forming on the outside of the refrigerator cabinet.

1. Use the OFF setting when humidity is low.
2. Use the ON setting if moisture forms on the outside of the refrigerator cabinet.

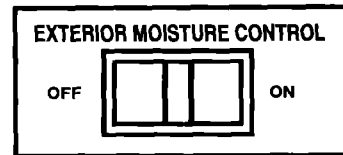

## Changing the control settings

If you need to adjust temperatures in refrigerator or freezer, use the settings listed in the chart below as a guide.

- Adjust the Refrigerator Control first.
- Wait at least 24 hours between adjustments.
- Then adjust the Freezer Control if needed.

CONDITION:	REASON:	RECOMMENDED CONTROL SETTINGS:
If Refrigerator Section is TOO WARM	Door opened often Large amount of food added Room temperature too warm	Refrigerator 6 Freezer D
If Freezer Section is TOO WARM	Door opened often Large amount of food added Very cold room temperature (can't cycle often enough)	Refrigerator 4 Freezer A
If Refrigerator Section is TOO COLD	Controls not set correctly for your conditions	Refrigerator 2 Freezer A
If ICE isn't MADE FAST ENOUGH	Heavy ice usage Very cold room temperature (can't cycle often enough)	Refrigerator 4 Freezer A
If BOTH SECTIONS are TOO WARM	Door opened often Large amount of food added Very warm or very cold room temperatures	Refrigerator 6 Freezer C



## Adjusting the door bins

### To remove door bins:

1. Lift bin up.
2. Pull bin straight out.

### To replace door bins:

1. Slide bin in above desired support button.
2. Push down until it stops.

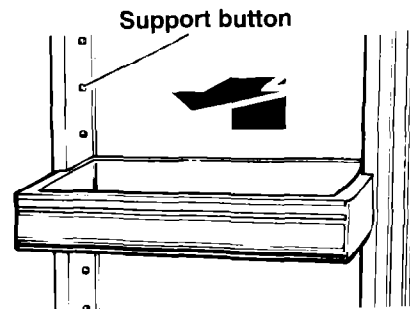

## Adjusting the bin/shelf glides

The bin/shelf glides can be used to secure odd-shaped items or to separate other items.

1. Grasp glide.
2. Slide glide along bin/track.

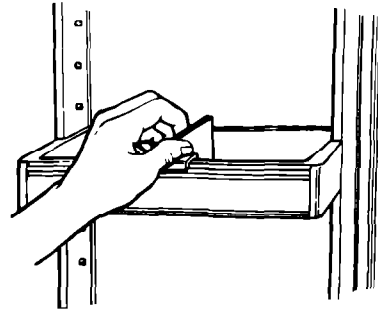

## Adjusting the refrigerator shelves

Shelves can be adjusted to match the way you use your refrigerator. Glass shelves are strong enough to hold bottles, milk and other heavy food items.

### To remove glass shelves:

1. Remove items from shelf.
2. Tilt shelf up at front.
3. Lift back of shelf.
4. Pull shelf straight out.

### To replace glass shelves:

1. Guide the rear shelf hooks into the slots in the shelf supports on cabinet wall.
2. Tilt shelf up at front until hooks drop into slots. Lower front of shelf to level position.

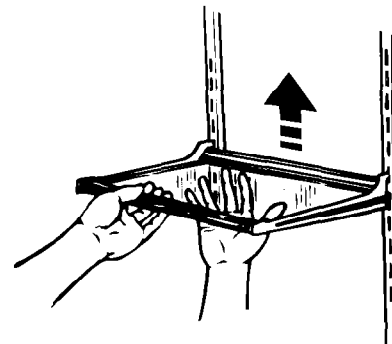

**Glass shelves are heavy. Be careful.**

## Removing the meat drawer and cover

### To remove the meat drawer:

1. Slide meat drawer out to the stop.
2. Lift front of meat drawer.
3. Slide meat drawer out the rest of the way.
4. Replace in reverse order.

### To remove the cover:

1. Tilt front of cover up.
2. Lift back of cover.
3. Pull cover straight out.
4. Replace cover in reverse order.

Pull out to the stop,  
lift the front and pull  
again.

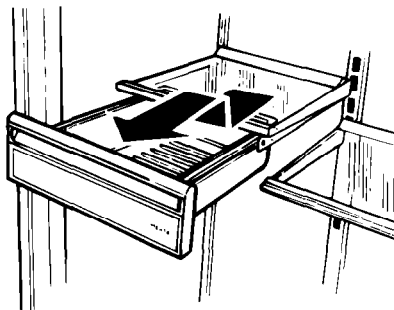

## Removing the crispers and crisper cover

### To remove the crispers:

1. Slide the crisper straight out to the stop.
2. Lift the front.
3. Slide out the rest of the way.
4. Replace in reverse order.

Pull out to the  
stop, lift the front  
and pull again.

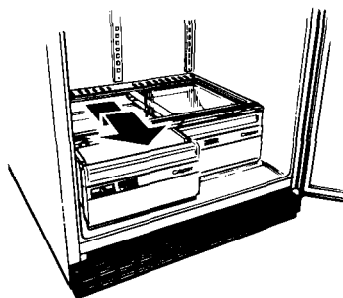

### To remove the cover:

1. Push up glass insert from the bottom, then slide it out with both hands.
2. Lift front of cover frame.
3. Pull cover frame up and out.
4. Remove metal cover support.

### To replace the cover:

1. Replace metal cover support on wall supports in front section of cabinet.
2. Fit back corner of cover frame into notch supports on walls of refrigerator, then lower front onto metal cover support.
3. Slide back of glass insert into cover frame. Then lower front to level position.

Remove the  
glass insert.  
Lift front of  
cover frame,  
then the  
back.

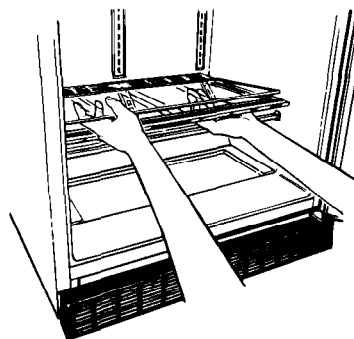

## Adjusting the crisper humidity control

You can control the amount of humidity in the moisture-sealed crisper.

- The control can be adjusted to any setting between LOW and HIGH.
- LOW (open) lets moist air out of the crisper for best storage of fruits and vegetables with skins.
- HIGH (closed) keeps moist air in the crisper for best storage of fresh, leafy vegetables.

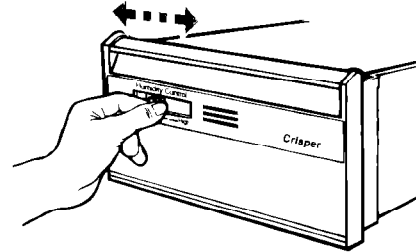

## Removing the freezer shelf (3VET21DK AND 3VET23DK)

The upper freezer shelf can be removed for easier cleaning.

**To remove the freezer shelf:**

1. Lift front of shelf slightly.
2. Lift back off supports.
3. Replace in reverse order.

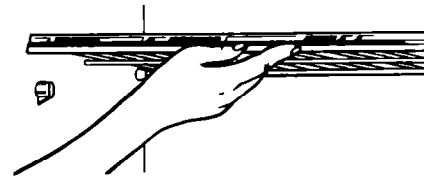

## Raising the ice compartment door

**To raise the door:**

1. Pull ice compartment door out from the bottom.
2. Slide it to the rear of cabinet.

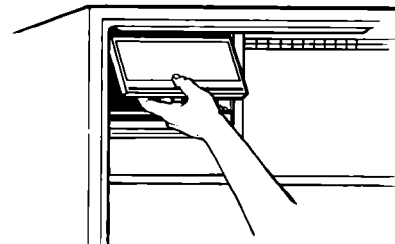

## Using the ice cube trays

If cubes are not used, they may shrink. The moving cold air starts a slow evaporation. The longer cubes are stored, the smaller they get.

**To remove ice:**

1. Hold tray at both ends.
2. Twist slightly.

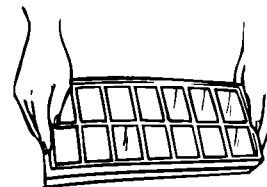

## Changing the light bulbs

### **⚠ WARNING**

#### **Electrical Shock Hazard**

Before removing a light bulb, either unplug the refrigerator or disconnect the electricity leading to the refrigerator at the main power supply.

Failure to do so could result in electrical shock or personal injury.

#### **To change the refrigerator light:**

1. Disconnect refrigerator from power supply.
2. Reach behind the Control Panel to remove bulb.
3. Replace with a 40-watt appliance bulb.
4. Reconnect refrigerator to power supply.

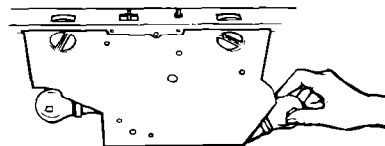

#### **To change freezer light (3VET23DK):**

1. Disconnect refrigerator from power supply.
2. Grasp the top and bottom of the light shield.
3. Squeeze and pull light shield out.
4. Replace with a 25-watt appliance bulb.
5. Snap light shield into place.
6. Reconnect refrigerator to power supply.

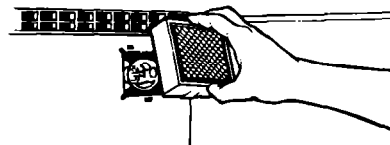

**NOTE:** Not all commercial appliance bulbs will fit your refrigerator. Be sure to replace a bulb with one of the same size and shape.

## Removing the base grille

#### **To remove the grille:**

1. Open refrigerator door.
2. Pull base grille forward to release the support tabs from the metal clips.
3. **Do not remove Tech Sheet** fastened behind the grille.

#### **To replace the grille:**

1. Line up grille support tabs with metal clips.
2. Push firmly to snap into place.
3. Close refrigerator door.

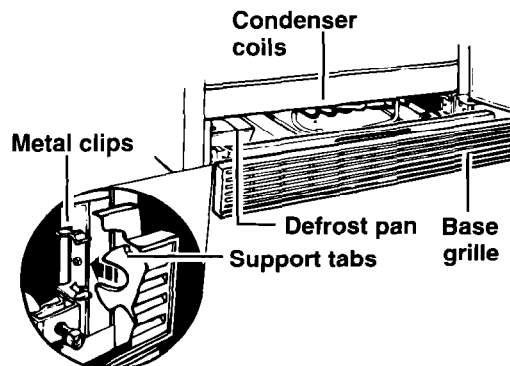

See cleaning instructions for defrost pan and condenser coils on page 15.

## Reversing the door swing

You can change the hinges on your refrigerator so the doors open the other way. Refer to the instruction sheet included with your refrigerator.

## Understanding the sounds you may hear

Your new refrigerator may make sounds that your old one didn't. Because the sounds are new to you, you might be concerned about them. Don't be. Most of the new sounds are normal. Hard surfaces like the floor, walls and cabinets can make the sounds seem louder.

The following describes the kinds of sounds that might be new to you, and what may be making them.

### **Slight hum, soft hiss**

You may hear the refrigerator's fan motor and moving air.

### **Clicking or snapping sounds**

The thermostat makes a definite click when the refrigerator stops running. It also makes a sound when the refrigerator starts. The defrost timer will click when the defrost cycle starts.

## Saving energy

You can help your refrigerator use less electricity.

- Check door gaskets for a tight seal. Level the cabinet to be sure of a good seal.
- Clean the condenser coils regularly.
- Open the door as few times as possible. Think about what you need before you open the door. Get everything out at one time. Keep food organized so you won't have to search for what you want. Close door as soon as food is removed.
- Go ahead and fill up the refrigerator, but don't overcrowd it so air movement is blocked.

### **Water sounds**

When the refrigerator stops running, you may hear gurgling in the tubing for a few minutes after it stops. You may also hear defrost water running into the defrost water pan.

### **Running sounds**

Your refrigerator has a high-efficiency compressor and motor. It will run longer than older designs. It may even seem to run most of the time.

- It is a waste of electricity to set the refrigerator and freezer to temperatures colder than they need to be. If ice cream is firm in the freezer and drinks are as cold as your family likes them, that's cold enough.
- Make sure your refrigerator is not next to a heat source such as a range, water heater, furnace, radiator or in direct sunlight.

# Caring For Your Refrigerator

In This Section		Page	Page
Cleaning your refrigerator .....	14	Power interruptions .....	16
Holiday and moving care .....	15		

Your refrigerator is built to give you many years of dependable service. However, there are a few things you can do to help extend its product life. This section will tell you how to clean your refrigerator and what to do when going on holiday, moving or during a power outage.

## Cleaning your refrigerator

Both the refrigerator and freezer sections defrost automatically. But both should be cleaned about once a month to help prevent odors from building up. Spills should be wiped up right away.

To clean your refrigerator, turn the Refrigerator Control to OFF, unplug it, take out all removable parts and clean the refrigerator according to the following directions.

**⚠ WARNING**

**Personal Injury Hazard**

Refrigeration system tubes are located near the defrost pan and can become hot. Remove and install defrost pan carefully. Failure to do so could result in personal injury.

PART	WHAT TO USE	HOW TO CLEAN
<b>Removable parts</b> (shelves, crisper, etc.)	Sponge or cloth with mild detergent and warm water	<ul style="list-style-type: none"> <li>• Hand wash, rinse and dry thoroughly.</li> </ul>
<b>Outside</b>	Sponge, cloth or paper towel with mild detergent, warm water and an appliance wax (or good auto paste wax)	<ul style="list-style-type: none"> <li>• Wash outside of cabinet. Do not use abrasive or harsh cleaners.</li> <li>• Rinse and dry thoroughly.</li> <li>• Wax painted metal surfaces at least twice a year. Apply wax with a clean, soft cloth. <b>Waxing painted metal surfaces provides rust protection. Do not wax plastic parts.</b></li> </ul>
<b>Inside walls</b> (freezer should be allowed to warm up so cloth won't stick)	Sponge, soft cloth or paper towel with baking soda or mild detergent and warm water	<ul style="list-style-type: none"> <li>• Wash with mixture of warm water and – mild detergent, or – baking soda (26 g [2 tablespoons] to 0.95 L [1 quart] of water).</li> <li>• Rinse and dry thoroughly.</li> </ul>
<b>Door liners and gaskets</b>	Sponge, soft cloth or paper towel with mild detergent and warm water	<ul style="list-style-type: none"> <li>• Wash, rinse and dry thoroughly.</li> </ul> <p><b>DO NOT USE cleaning waxes, concentrated detergents, bleaches or cleaners containing petroleum on plastic parts.</b></p>
<b>Plastic parts</b> (covers and panels)	Soft, clean sponge or soft, clean cloth with mild detergent and warm water	<ul style="list-style-type: none"> <li>• Wash, rinse and dry thoroughly.</li> </ul> <p><b>DO NOT USE paper towels, window sprays, scouring cleansers or flammable fluids. These can scratch or damage material. See "Important Safety Instructions" on page 3.</b></p>

PART	WHAT TO USE	HOW TO CLEAN
<b>Defrost pan</b> (behind refrigerator on top of motor)	Sponge or cloth with mild detergent and warm water	<ul style="list-style-type: none"> <li>• Remove base grille. (See page 12.)</li> <li>• To remove defrost pan, lift pan over wire brace (remove tape; if any).</li> <li>• Wash, rinse and dry thoroughly.</li> <li>• Replace with notched corner to the rear. Push it in all the way.</li> <li>• Make sure defrost pan drain tube is pointing into pan.</li> <li>• Replace base grille.</li> </ul>
<b>Condenser coils</b>	Vacuum cleaner with extended narrow attachment	<ul style="list-style-type: none"> <li>• Remove base grille.</li> <li>• Vacuum coils when dusty or dirty. Coils may need to be cleaned as often as every other month.</li> <li>• Replace base grille.</li> </ul>
<b>Floor under refrigerator</b>	Floor cleaners	<ul style="list-style-type: none"> <li>• Roll refrigerator out only as far as the water supply line allows.</li> <li>• Clean floor.</li> <li>• Roll refrigerator back into place.</li> <li>• Check to see if the refrigerator is level.</li> </ul>

## Holiday and moving care

### Long holidays

Remove all the food if you are going for a month or more.

Unplug the refrigerator. Clean, rinse it well and dry. Tape rubber or wood blocks to the tops of both doors to prop them open far enough for air to get in. This will keep odor and mold from building up.

### **⚠ WARNING**

#### **Personal Injury Hazard**

Do not allow children to climb on, play near or climb inside the refrigerator when the doors are blocked open. They may become injured or trapped.

### Short holidays

No need to shut off the refrigerator if you will be away for less than four weeks. Use up perishables; freeze other items.

### Moving

Remove all food. Pack frozen food in dry ice. Unplug the refrigerator and clean it thoroughly.

Take out all removable parts. Wrap all parts well and tape them together so they don't shift and rattle. Screw in the leveling legs; tape the doors shut; and tape the electric cord to the cabinet.

When you get to your new home, put everything back and refer to page 5.

To restart refrigerator, see "Using Your Refrigerator" on page 7.

## Power interruptions

If electricity goes off, call the power company. Ask how long power will be off.

1. If service is to be interrupted 24 hours or less, **keep both doors closed**. This will help foods stay frozen.
2. If service is to be interrupted longer than 24 hours:
  - (a) Remove all frozen food and store in a frozen food locker.

**OR**

- (b) Place 32 grams of dry ice for every liter of freezer space (2 lbs. of dry ice for every cubic foot of freezer space). This will keep food frozen for 2 to 4 days. Wear gloves to protect your hands from dry ice burns.

**OR**

- (c) If neither a food locker or dry ice is available, use or can perishable food at once.
3. A full freezer will stay cold longer than a partly filled one. A freezer full of meat will stay cold longer than a freezer full of baked goods. If food contains ice crystals, it may be safely refrozen, although the quality and flavor may be affected. If the condition of the food is poor or if you feel it is unsafe, dispose of it.

# Food Storage Guide

In This Section	Page	Page	
Storing fresh food .....	16	Storing frozen food .....	17

There is a correct way to package and store refrigerated or frozen food. To keep food fresher, longer, take the time to study these recommended steps.

## Storing fresh food

Food placed in the refrigerator should be wrapped or stored in air and moisture proof material. This prevents food odor and taste transfer throughout the refrigerator. For dated products, check code date to ensure freshness.

### Leafy vegetables

Remove store wrapping and trim or tear off bruised and discolored areas. Wash in cold water and drain. Place in plastic bag or plastic container and store in crisper.

### Vegetables with skins (carrots, peppers)

Store in crisper, plastic bags or plastic container.

### Fruit

Wash, let dry and store in refrigerator in plastic bags or crisper. Do not wash or hull berries until they are ready to use. Sort and keep berries in their store container in a crisper, or store in a loosely closed paper bag on a refrigerator shelf.



**Eggs**

Store without washing in the original carton on interior shelf.

**Milk**

Wipe milk cartons. For best storage, place milk on interior shelf.

**Butter or margarine**

Keep opened butter in covered dish or closed compartment. When storing an extra supply, wrap in freezer packaging and freeze.

**Cheese**

Store in the original wrapping until you are ready to use it. Once opened, rewrap tightly in plastic wrap or aluminum foil.

**Leftovers**

Cover leftovers with plastic wrap or aluminum foil. Plastic containers with tight lids can also be used.

**Storing frozen food**

The freezer section is designed for storage of commercially frozen food and for freezing food at home.

**NOTE:** For further information about preparing food for freezing or storage times, contact your local Cooperative Extension Service or check a freezer guide or cookbook.

**Packaging**

The secret of successful freezing is in the packaging. The way you close and seal the package must not allow air or moisture in or out. Packaging done in any other way could cause food odor and taste transfer throughout the refrigerator and drying of frozen food.

**Packaging recommended for use:**

- Rigid plastic containers with tight-fitting lids
- Straight-sided canning/freezing jars
- Heavy-duty aluminum foil
- Plastic-coated paper
- Non-permeable plastic wraps (made from a saran film)

Follow package or container instructions for proper freezing methods.

**Meat**

Most meat can be stored in original wrapping as long as it is air and moisture proof. Rewrap if necessary. See the following chart for storage times.

TYPE	APPROXIMATE TIME (DAYS) <sup>†</sup>
Chicken	1 to 2
Ground beef	1 to 2
Steaks and roasts	3 to 5
Cured meats	7 to 10
Bacon	5 to 7
Cold cuts	3 to 5
Variety meats	1 to 2

<sup>†</sup>If meat is to be stored longer than the times given, follow the directions for freezing.

**NOTE:** Fresh fish and shellfish should be used the same day as purchased.

**Do not use:**

- Bread wrappers
- Non-polyethylene plastic containers
- Containers without tight lids
- Waxed paper
- Waxed-coated freezer wrap
- Thin, semi-permeable wrap

The use of these wrappings could cause food odor, taste transfer and drying of frozen food.

**Freezing**

Do not expect your freezer to quick-freeze any large quantity of food. Put no more unfrozen food into the freezer than will freeze within 24 hours. (No more than 32 to 48 grams of food per liter of freezer space [2 to 3 lbs. of food per cubic foot of freezer space].) Leave enough space for air to circulate around packages. Be careful to leave enough room at the front so the door can close tightly.

Storage times will vary according to the quality of the food, the type of packing or wrap used (air and moisture proof) and the storage temperature (which should be -17.8°C [0°F]).

# If You Need Assistance Or Service

This section is designed to help you save the cost of a service call. First we outline possible problems, their causes and their solutions. However, you may still need assistance or service. When calling an authorized Whirlpool service company for help or calling for service, you will need to provide a complete description of the problem, your appliance's complete model and serial numbers and the purchase date. (See page 2.) This information is needed to respond to your request properly.

## 1. Before calling for assistance ...

Performance problems often result from little things you can find and fix without tools of any kind. Please check the chart below for problems you can fix. It could save you the cost of a service call.

<b>PROBLEM</b>	<b>POSSIBLE CAUSE</b>	<b>SOLUTION</b>
<b>Your refrigerator will not operate</b>	The power supply cord is not plugged into a live circuit with proper voltage. A household fuse has blown or circuit breaker tripped. The Refrigerator Control is not set correctly.	Firmly plug power cord into a live circuit with proper voltage. (See page 5.) Replace household fuse or reset circuit breaker. Set Refrigerator Control to a numbered setting. (See page 7.)
<b>Unfamiliar sounds or a rattling/jingling noise</b>	There is something on top of or behind the refrigerator. The sounds are normal.	Remove item from on top of or behind the refrigerator. New features on your new refrigerator make new sounds. (See "Understanding the sounds you may hear" on page 13.)
<b>There is water in the defrost pan</b>	This is normal in hot, muggy weather. The pan may even be half full.	Make sure the refrigerator is level so the pan does not overflow.
<b>The lights do not work</b>	A household fuse has blown or circuit breaker tripped. The power supply cord is not plugged into a live circuit with proper voltage. The bulb is burned out.	Replace household fuse or reset circuit breaker. Firmly plug power cord into a live circuit with proper voltage. (See page 5.) Replace bulb. (See page 12.)
<b>The motor seems to run too much</b>	The condenser coils are dirty. It is hot outside or in the room. The door has been opened frequently. A large amount of food has been put in at one time.	Clean the coils (See page 15.) On hot days, or if the room is too warm, the motor naturally runs longer. Open the door as few times as possible. The motor will run longer in order to cool down the interior when food is added.

**Remember:**

Motor running time depends on different things: number of door openings, amount of food stored, temperature of the room, setting of controls, etc.

Your new refrigerator may be larger than your old one so it has more space to be cooled. It also has a regular freezer instead of a frozen food compartment. All this means better refrigeration and may require more running time than your old one.

**2. If the problem is not due to one of the items listed in Step 1 ...**

Contact the dealer from whom you purchased the unit or an authorized Whirlpool service company.

**3. If you need FSP\* replacement parts ...**

FSP is a registered trademark of Whirlpool Corporation for quality parts. Look for this symbol of quality whenever you need a replacement part for your Whirlpool appliance. FSP replacement parts will fit right and work right, because they are made to the same exacting specifications used to build every new Whirlpool appliance.

To locate FSP replacement parts in your area, contact the dealer from whom you purchased the unit or an authorized Whirlpool service company.

# WHIRLPOOL<sup>\*</sup>

## Refrigerator Warranty

LENGTH OF WARRANTY	WHIRLPOOL WILL PAY FOR
<b>FULL ONE-YEAR WARRANTY</b> From Date of Purchase	FSP* replacement parts and repair labor to correct defects in materials or workmanship. Service must be provided by an authorized Whirlpool service company.
<b>FULL FIVE-YEAR WARRANTY</b> From Date of Purchase	FSP replacement parts and repair labor to correct defects in materials or workmanship in the sealed refrigeration system. These parts are: <ol style="list-style-type: none"> <li>1. Compressor</li> <li>2. Evaporator</li> <li>3. Condenser</li> <li>4. Drier</li> <li>5. Connecting tubing</li> </ol> Service must be provided by an authorized Whirlpool service company.
<b>WHIRLPOOL WILL NOT PAY FOR</b>	
<p><b>A.</b> Service calls to:</p> <ol style="list-style-type: none"> <li>1. Correct the installation of the refrigerator.</li> <li>2. Instruct you how to use the refrigerator.</li> <li>3. Replace house fuses or correct house wiring or plumbing.</li> <li>4. Replace light bulbs.</li> </ol> <p><b>B.</b> Repairs when refrigerator is used in other than normal, single-family household use.</p> <p><b>C.</b> Pickup and delivery. This product is designed to be repaired in the home.</p> <p><b>D.</b> Damage to refrigerator caused by accident, misuse, fire, flood, acts of God or use of products not approved by Whirlpool.</p> <p><b>E.</b> Any food loss due to product failure.</p> <p><b>F.</b> Repairs to parts or systems caused by unauthorized modifications made to the appliance.</p>	

8-92

WHIRLPOOL CORPORATION SHALL NOT BE LIABLE FOR INCIDENTAL OR CONSEQUENTIAL DAMAGES.

Outside the United States, a different warranty may apply. For details, please contact your authorized Whirlpool distributor or military exchange.